

## Single Phase Full Controlled Bridges

### PSBT 125

$I_{dAV}$  = 123 A  
 $V_{RRM}$  = 400-1600 V

#### Preliminary Data Sheet

$V_{RSM}$ $V_{DSM}$	$V_{RRM}$ $V_{DRM}$	Type
500	400	PSBT 125/04
900	800	PSBT 125/08
1300	1200	PSBT 125/12
1500	1400	PSBT 125/14
*1700	*1600	PSBT 125/16

\* Delivery on request

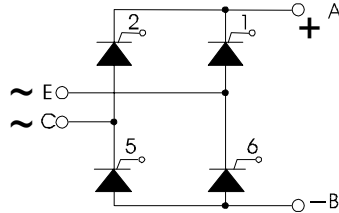

Symbol	Test Conditions	Maximum Ratings
$I_{dAV}$	$T_C = 85^\circ\text{C}$ , module	123 A
$I_{TSM}$	$T_{VJ} = 45^\circ\text{C}$ $V_R = 0$ $t = 10\text{ ms}$ (50 Hz), sine	1500 A
	$t = 8.3\text{ ms}$ (60 Hz), sine	1600 A
	$T_{VJ} = T_{VJM}$ $V_R = 0$ $t = 10\text{ ms}$ (50 Hz), sine	1350 A
	$t = 8.3\text{ ms}$ (60 Hz), sine	1450 A
$\int i^2 dt$	$T_{VJ} = 45^\circ\text{C}$ $V_R = 0$ $t = 10\text{ ms}$ (50 Hz), sine	11 200 $\text{A}^2\text{s}$
	$t = 8.3\text{ ms}$ (60 Hz), sine	10 750 $\text{A}^2\text{s}$
	$T_{VJ} = T_{VJM}$ $V_R = 0$ $t = 10\text{ ms}$ (50 Hz), sine	9100 $\text{A}^2\text{s}$
	$t = 8.3\text{ ms}$ (60 Hz), sine	8830 $\text{A}^2\text{s}$
$(di/dt)_{cr}$	$T_{VJ} = T_{VJM}$ $f = 400\text{Hz}$ , $t_p = 200\mu\text{s}$ $V_D = 2/3 V_{DRM}$ $I_G = 0.3\text{ A}$	repetitive, $I_T = 50\text{ A}$ 500 $\text{A}/\mu\text{s}$
	non repetitive, $I_T = 1/3 \cdot I_{dAV}$	500 $\text{A}/\mu\text{s}$
	$di_G/dt = 0.3\text{ A}/\mu\text{s}$	
$(dv/dt)_{cr}$	$T_{VJ} = T_{VJM}$ $V_{DR} = 2/3 V_{DRM}$ $R_{GK} = \infty$ , method 1 (linear voltage rise)	1000 $\text{V}/\mu\text{s}$
$P_{GM}$	$T_{VJ} = T_{VJM}$ $t_p = 30\mu\text{s}$	$\leq 10\text{ W}$
	$I_T = I_{TAVM}$ $t_p = 500\mu\text{s}$	$\leq 5\text{ W}$
$P_{GAVM}$		0.5 W
$V_{RGM}$		10 V
$T_{VJ}$		-40 ... + 125 $^\circ\text{C}$
$T_{VJM}$		125 $^\circ\text{C}$
$T_{stg}$		-40 ... + 125 $^\circ\text{C}$
$V_{ISOL}$	50/60 HZ, RMS $t = 1\text{ min}$	2500 V ~
	$I_{ISOL} \leq 1\text{ mA}$ $t = 1\text{ s}$	3000 V ~
$M_d$	Mounting torque (M6)	5 Nm
	Terminal connection torque (M6)	5 Nm
Weight	typ.	270 g

#### Features

- Package with screw terminals
- Isolation voltage 3000 V~
- Planar glasspassivated chips
- Low forward voltage drop
- UL released, E 148688

#### Applications

- Heat and temperature control for industrial furnaces and chemical processes
- Lighting control
- Motor control
- Power converter

#### Advantages

- Easy to mount with two screws
- Space and weight savings
- Improved temperature and power cycling capability
- High power density

#### Package, style and outline

Dimensions in mm (1mm = 0.0394")

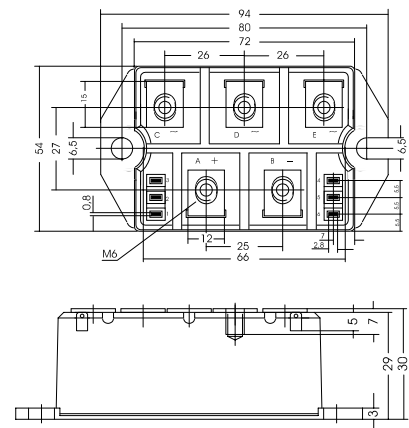

Symbol	Test Conditions	Characteristic Value	
$I_D, I_R$	$T_{VJ} = T_{VJM}, V_R = V_{RRM}, V_D = V_{DRM}$	$\leq 5$ mA	
$V_T$	$I_T = 200A, T_{VJ} = 25^\circ C$	$\leq 1.57$ V	
$V_{TO}$	For power-loss calculations only ( $T_{VJ} = T_{VJM}$ )	0.85 V	
$r_T$		3.5 mΩ	
$V_{GT}$	$V_D = 6V$	$T_{VJ} = 25^\circ C$	$\leq 1.5$ V
		$T_{VJ} = -40^\circ C$	$\leq 1.6$ V
$I_{GT}$	$V_D = 6V$	$T_{VJ} = 25^\circ C$	$\leq 100$ mA
		$T_{VJ} = -40^\circ C$	$\leq 200$ mA
$V_{GD}$	$T_{VJ} = T_{VJM}, V_D = 2/3 V_{DRM}$	$\leq 0.2$ V	
$I_{GD}$	$T_{VJ} = T_{VJM}, V_D = 2/3 V_{DRM}$	$\leq 5$ mA	
$I_L$	$T_{VJ} = 25^\circ C, t_p = 30\mu s$	$\leq 450$ mA	
	$I_G = 0.3A, di_G/dt = 0.3A/\mu s$		
$I_H$	$T_{VJ} = 25^\circ C, V_D = 6V, R_{GK} = \infty$	$\leq 200$ mA	
$t_{gd}$	$T_{VJ} = 25^\circ C, V_D = 1/2 V_{DRM}$	$\leq 2$ μs	
	$I_G = 0.3A, di_G/dt = 0.3A/\mu s$		
$t_q$	$T_{VJ} = T_{VJM}, I_T = 20A, t_p = 200\mu s, V_R = 100V$	150 μs	
	$-di/dt = 10A/\mu s, dv/dt = 15V/\mu s, V_D = 2/3 V_{DRM}$		
$R_{thJC}$	per thyristor; sine 180°el	0.46 K/W	
	per module	0.115 K/W	
$R_{thJK}$	per thyristor; sine 180° el	0.55 K/W	
	per module	0.1375 K/W	
$d_s$	Creeping distance on surface	10 mm	
$d_A$	Creeping distance in air	9.4 mm	
$a$	Max. allowable acceleration	50 m/s <sup>2</sup>	

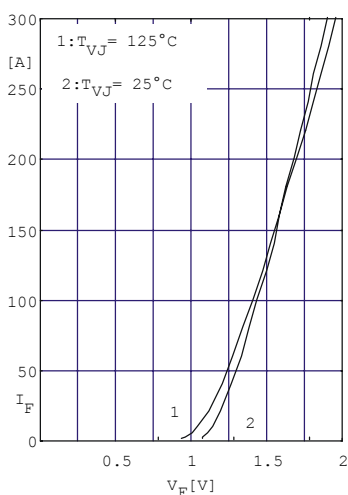

Fig. 1 Forward current vs. voltage drop per diode or thyristor

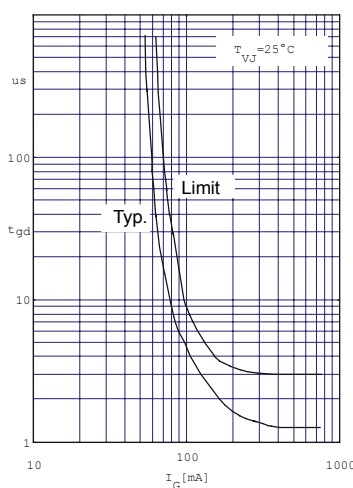

Fig. 2 Gate trigger delay time

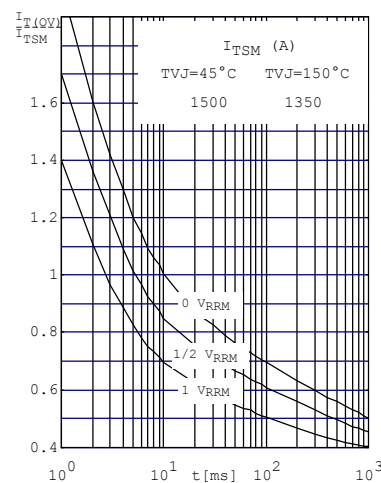

Fig. 3 Surge overload current per diode (or thyristor)  $I_{FSM}$ ,  $I_{TSM}$ : Crest value t: duration



Fig.4 Gate trigger characteristic

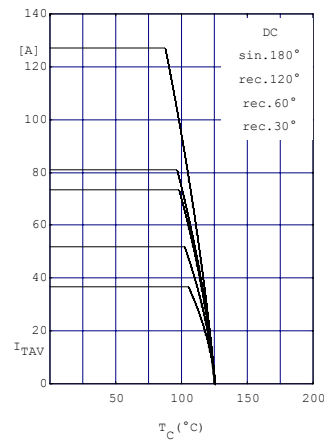

Fig.5 Maximum forward current at case temperature

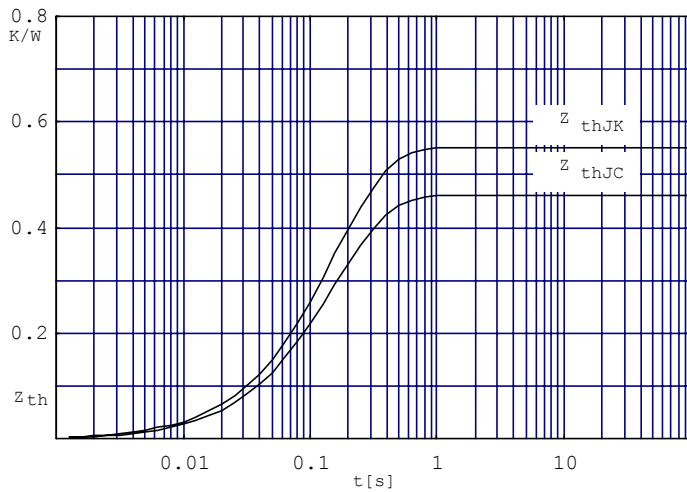

Fig.6 Transient thermal impedance per thyristor or diode (calculated)

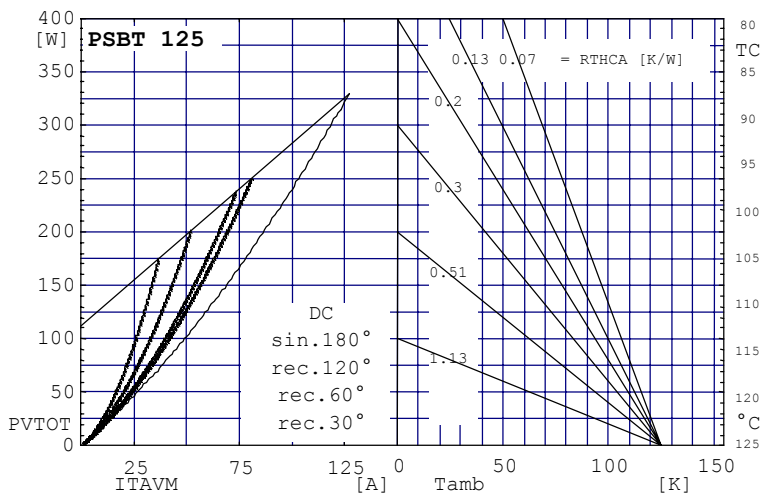

Fig. 7 Power dissipation vs. direct output current and ambient temperature