

Single Phase Half Controlled Bridges

PSBZ 75

I_{TAVM} = 74 A
 V_{RRM} = 400-1600 V

Preliminary Data Sheet

V_{RSM} V_{DSM}	V_{RRM} V_{DRM}	Type
500	400	PSBZ 75/04
900	800	PSBZ 75/08
1300	1200	PSBZ 75/12
1500	1400	PSBZ 75/14
*1700	*1600	PSBZ 75/16

* Delivery on request

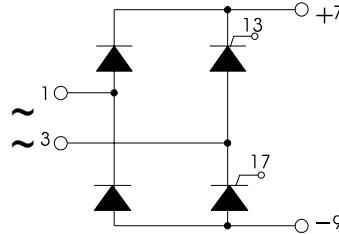

Symbol	Test Conditions	Maximum Ratings
I_{TAVM}	$T_C = 85^\circ\text{C}$ per module	74 A
I_{FSM}, I_{TSM}	$T_{VJ} = 45^\circ\text{C}$ $V_R = 0$ $t = 10\text{ ms}$ (50 Hz), sine	1150 A
	$t = 8.3\text{ ms}$ (60 Hz), sine	1230 A
	$T_{VJ} = T_{VJM}$ $V_R = 0$ $t = 10\text{ ms}$ (50 Hz), sine	1000 A
	$t = 8.3\text{ ms}$ (60 Hz), sine	1070 A
$\int i^2 dt$	$T_{VJ} = 45^\circ\text{C}$ $V_R = 0$ $t = 10\text{ ms}$ (50 Hz), sine	6600 A^2s
	$t = 8.3\text{ ms}$ (60 Hz), sine	6280 A^2s
	$T_{VJ} = T_{VJM}$ $V_R = 0$ $t = 10\text{ ms}$ (50 Hz), sine	5000 A^2s
	$t = 8.3\text{ ms}$ (60 Hz), sine	4750 A^2s
$(di/dt)_{cr}$	$T_{VJ} = T_{VJM}$ repetitive, $I_T = 150\text{ A}$ $f = 50\text{ Hz}$, $t_p = 200\mu\text{s}$ $V_D = 2/3 V_{DRM}$	100 $\text{A}/\mu\text{s}$
	$I_G = 0.3\text{ A}$ non repetitive, $I_T = I_{TAVM}$	500 $\text{A}/\mu\text{s}$
	$di_G/dt = 0.3\text{ A}/\mu\text{s}$	
$(dv/dt)_{cr}$	$T_{VJ} = T_{VJM}$ $V_{DR} = 2/3 V_{DRM}$ $R_{GK} = \infty$, method 1 (linear voltage rise)	1000 $\text{V}/\mu\text{s}$
P_{GM}	$T_{VJ} = T_{VJM}$ $t_p = 30\mu\text{s}$	10 W
	$I_T = I_{TAVM}$ $t_p = 300\mu\text{s}$	5 W
P_{GAVM}		0.5 W
V_{RGM}		10 V
T_{VJ}		-40 ... + 125 $^\circ\text{C}$
T_{VJM}		125 $^\circ\text{C}$
T_{stg}		-40 ... + 125 $^\circ\text{C}$
V_{ISOL}	50/60 HZ, RMS $t = 1\text{ min}$	2500 V ~
	$I_{ISOL} \leq 1\text{ mA}$ $t = 1\text{ s}$	3000 V ~
M_d	Mounting torque (M5)	5 Nm
	Terminal connection torque (M3)	1.5 Nm
	(M5)	5 Nm
Weight	typ.	220 g

Features

- Package with screw terminals
- Isolation voltage 3000 V~
- Planar glasspassivated chips
- Low forward voltage drop
- UL registered E 148688

Applications

- Heat and temperature control for industrial furnaces and chemical processes
- Lighting control
- Motor control
- Power converter

Advantages

- Easy to mount with two screws
- Space and weight savings
- Improved temperature and power cycling capability
- High power density

Package, style and outline

Dimensions in mm (1mm = 0.0394")

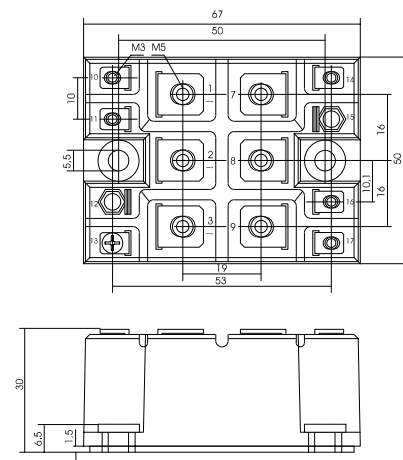

Symbol	Test Conditions	Characteristic Value			
I_D, I_R	$T_{VJ} = T_{VJM}, V_R = V_{RRM}, V_D = V_{DRM}$	\leq	5	mA	
V_T	$I_T = 150A, T_{VJ} = 25^\circ C$	\leq	1.57	V	
V_{TO}	For power-loss calculations only ($T_{VJ} = T_{VJM}$)		0.85	V	
r_T			5.33	m Ω	
V_{GT}	$V_D = 6V$	$T_{VJ} = 25^\circ C$	\leq	1.0	V
		$T_{VJ} = -40^\circ C$	\leq	1.6	V
I_{GT}	$V_D = 6V$	$T_{VJ} = 25^\circ C$	\leq	100	mA
		$T_{VJ} = -40^\circ C$	\leq	150	mA
V_{GD}	$T_{VJ} = T_{VJM}, V_D = 2/3 V_{DRM}$	\leq	0.2	V	
I_{GD}	$T_{VJ} = T_{VJM}, V_D = 2/3 V_{DRM}$	\leq	5	mA	
I_L	$T_{VJ} = 25^\circ C, t_p = 10\mu s$	\leq	200	mA	
	$I_G = 0.3A, di_G/dt = 0.3A/\mu s$				
I_H	$T_{VJ} = 25^\circ C, V_D = 6V, R_{GK} = \infty$	\leq	150	mA	
t_{gd}	$T_{VJ} = 25^\circ C, V_D = 1/2 V_{DRM}$	\leq	2	μs	
	$I_G = 0.3A, di_G/dt = 0.3A/\mu s$				
t_q	$T_{VJ} = T_{VJM}, I_T = 20A, t_p = 200\mu s, V_R = 100V$		150	μs	
	$-di/dt = 10A/\mu s, dv/dt = 15V/\mu s, V_D = 2/3 V_{DRM}$				
R_{thJC}	per thyristor; sine 180°el		0.66	K/W	
	per module		0.165	K/W	
R_{thJK}	per thyristor; sine 180° el		0.93	K/W	
	per module		0.2325	K/W	
d_s	Creeping distance on surface		8.0	mm	
d_A	Creeping distance in air		4.5	mm	
a	Max. allowable acceleration		50	m/s ²	

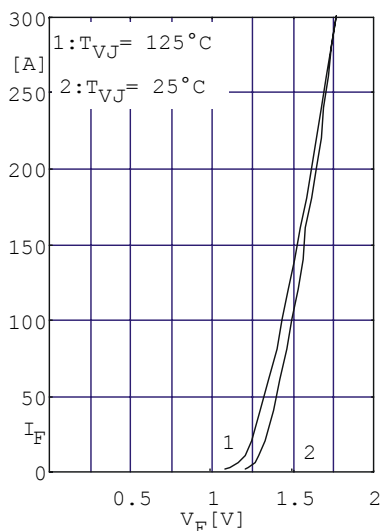

Fig. 1 Forward current vs. voltage drop per diode or thyristor

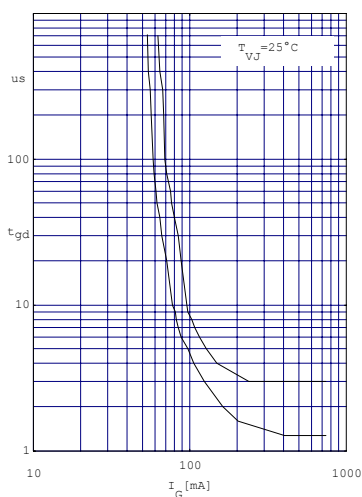

Fig. 2 Gate trigger delay time

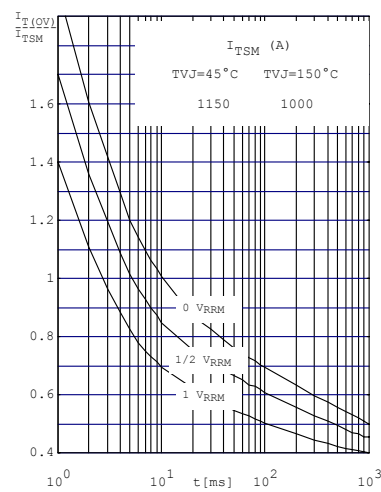

Fig. 3 Surge overload current per diode (or thyristor) I_{FSM} , I_{TSM} : Crest value t : duration



Fig.4 Gate trigger characteristic

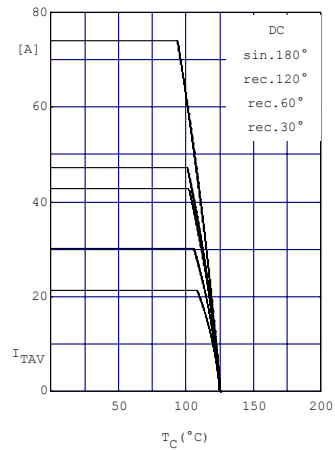

Fig.5 Maximum forward current at case temperature

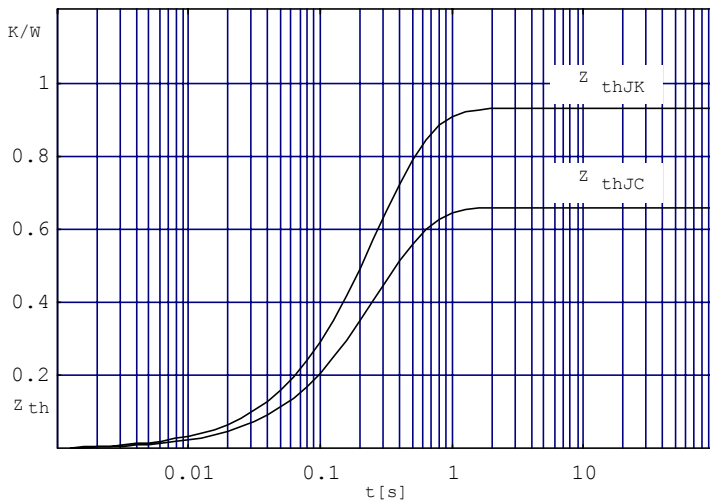

Fig.6 Transient thermal impedance per thyristor or diode (calculated)

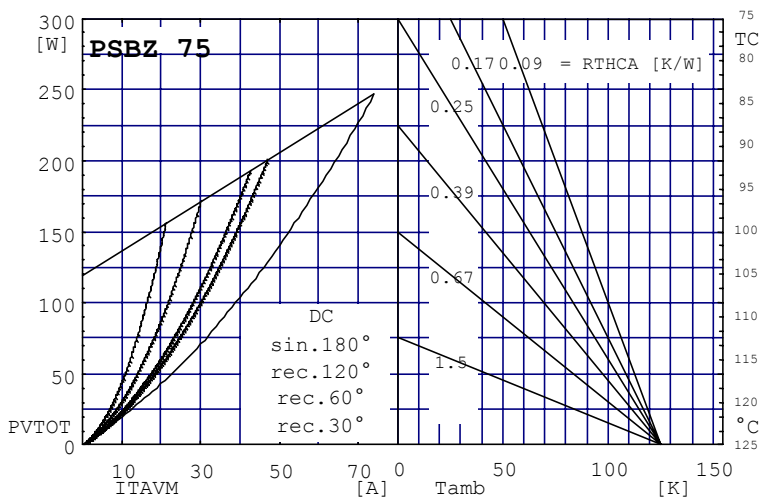

Fig. 7 Power dissipation vs. direct output current and ambient temperature